

CENTRO INSET COUNTERTOP WASHBASIN

(HEIGHT OF RIM 120 MM)

- fusion of minimalism and simple elegance
- luxurious look – integrates perfectly both in modern and traditional bathroom settings
- circle taken as the basic shape echoes in the perfectly integrated enamelled waste
- matching counterpart to the CENTRO DUO bath
- washbasin surround with ample space for individual accessories
- designed by Anke Salomon



Similar illustration

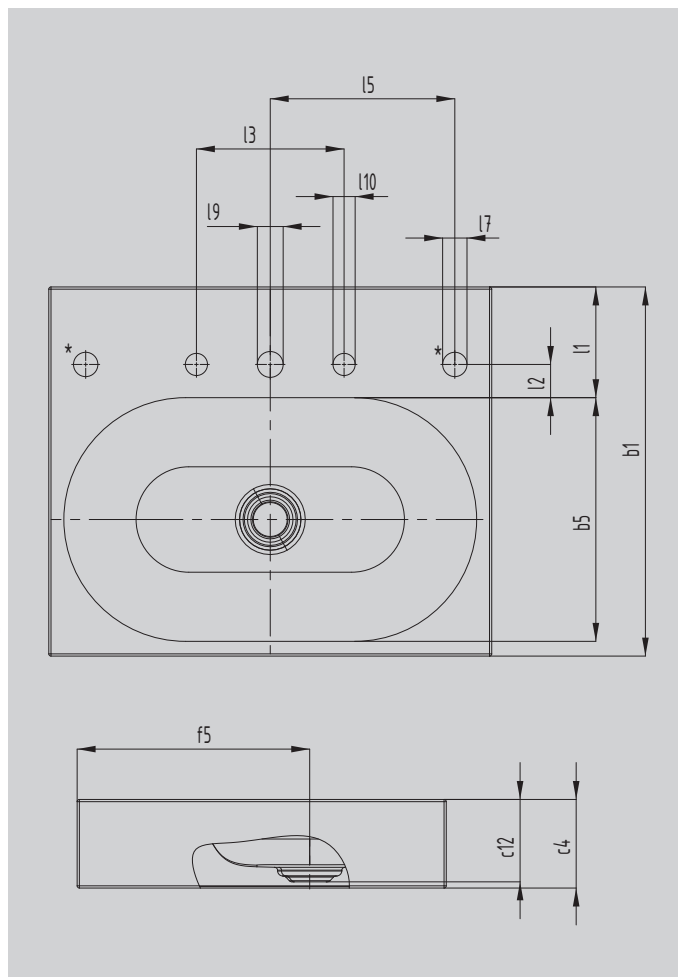

* Rotary knob hole for waste and overflow valve CLOU with cable pull and rotary knob optionally on the right or left

Model		3057
External length	a_1	600 mm
Internal length	a_5	559 mm
External width	b_1	500 mm
Internal width	b_5	330 mm
Height of rim	c_4	120 mm
Distance basin surface to bottom edge of waste hole	c_{12}	112 mm
Distance rear edge to centre of waste hole	f_5	315 mm
Depth of tap deck	l_1	150 mm
Distance tap holes to edge	l_2	45 mm
Distance external tap holes (for 3 tap holes)	l_3	200 mm
Distance tap hole to centre of control knob hole	l_5	250 mm
Diameter of control knob hole	l_7	Ø 33 mm
Diameter of centre tap hole	l_9	Ø 35 mm
Diameter of outside tap hole (for 3 tap holes only)	l_{10}	Ø 30 mm
Net weight		13 kg